



# Welcome

## Self-Certification Permit Program Update on the *Chicago Construction Codes*

December 2019

Presented by:  
Grant Ullrich, Deputy Commissioner



CITY OF CHICAGO  
DEPARTMENT OF  
**BUILDINGS**



# Schedule

## Schedule: Tuesday, December 10

- 8:30 AM      **Morning Session 1**  
Welcome and Introduction  
Code Organization and Definitions  
Occupancy Classification  
Construction Types  
Height and Area  
Special Features, Uses and Occupancies
- 10:45 AM      **Morning Session 2**  
Means of Egress  
Fire-resistance Rated Construction

## Schedule (continued)

- 1:00 PM      **Afternoon Session 1**  
Interior Finishes  
Fire Protection and Life Safety Systems  
Structural Basics
- 2:30 PM      **Afternoon Session 2**  
Introduction to the *Building Rehabilitation Code*  
Repairs and *Minimum Requirements*
- 3:45 PM      **Afternoon Session 3**  
Work Area Method
- 4:45 PM      **Discussion and Conclusion**



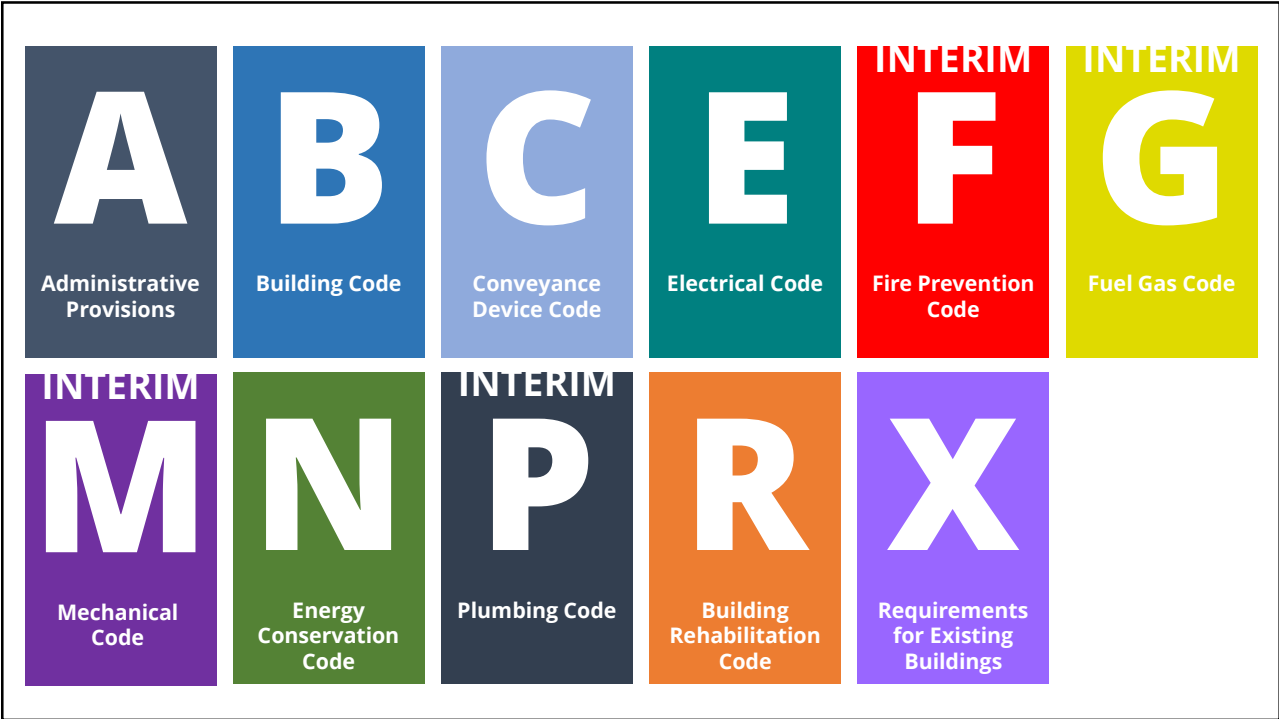
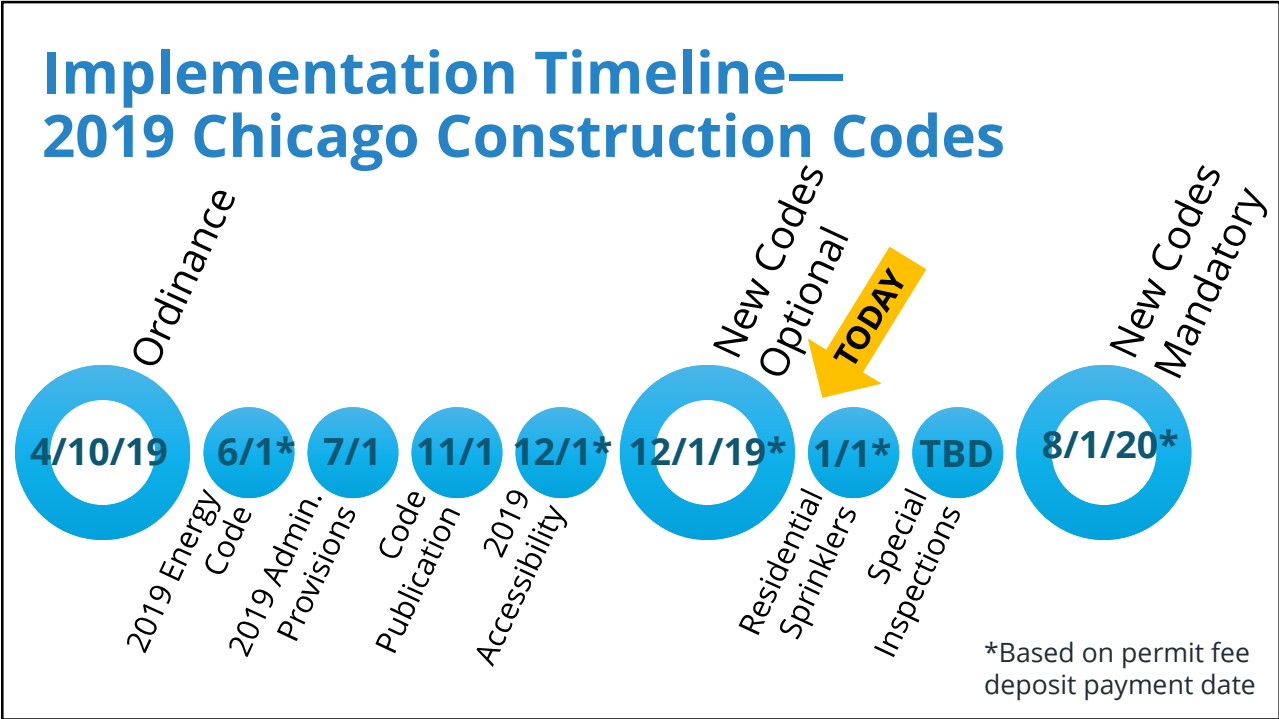

## Code Modernization— Phase 3

- Currently preparing for Phase 3a Codes
  - Plumbing
  - Mechanical
  - Fuel Gas
- Send suggestions to [DOBCommissioner@cityofchicago.org](mailto:DOBCommissioner@cityofchicago.org)
- Plumbing Pilot Program extended to 7/31/20



## 2019 Chicago Construction Codes— Self-Certification Permit Program

- January 1, 2020 is first day to start self-certified application under *Chicago Construction Codes* (structural peer review not required)
- February 1, 2020 is first day to start self-certified application under *Chicago Construction Codes* with structural peer review
  - Structural peer reviewer must have taken update class ([January 28, 2020](#))

## 2019 Chicago Construction Codes— Self-Certification Permit Program

- Continuing self-certification professionals may self-certify under either new code or old code through July 2020

### **No mix-and-match!**

- Self-certification professionals first certified in 2019 (or renewing after lapse) may only self certify under new code, starting 1/1/20 (or 2/1/20 if peer-review required)



## Morning Session 1: Fundamentals and Building Planning

- ① Code Organization and Definitions
- ② Occupancy Classification
- ③ Types of Construction
- ④ Height and Area Limitations
- ⑤ Special Building Features, Uses, and Occupancies

An architectural drawing or blueprint is shown in a warm, orange-toned background. A pencil is visible, pointing towards the drawing. The drawing includes various lines, dimensions, and annotations, typical of a technical drawing.

## Code Organization and Definitions

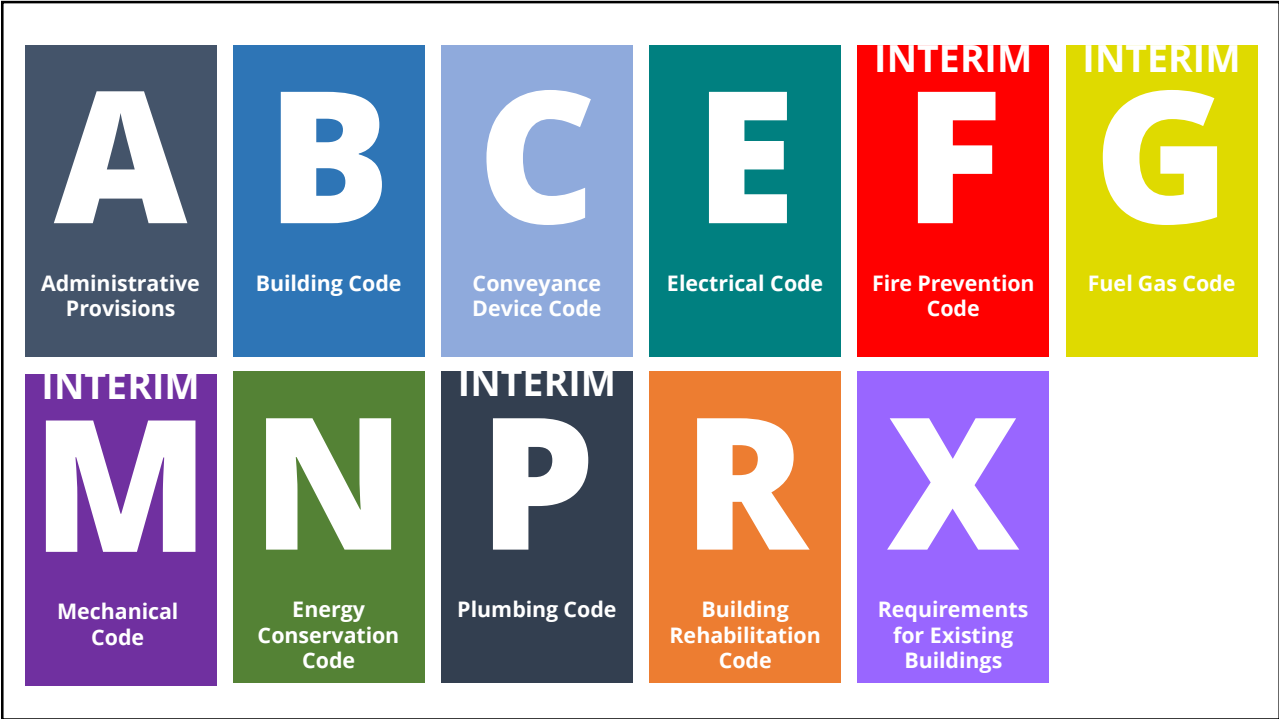



## Finding the New Codes

- 1 <http://www.chicago.gov/dob>
- 2 Scroll to bottom of any page on the Department of Buildings' website and click "Chicago Construction Codes" in Quick Links:

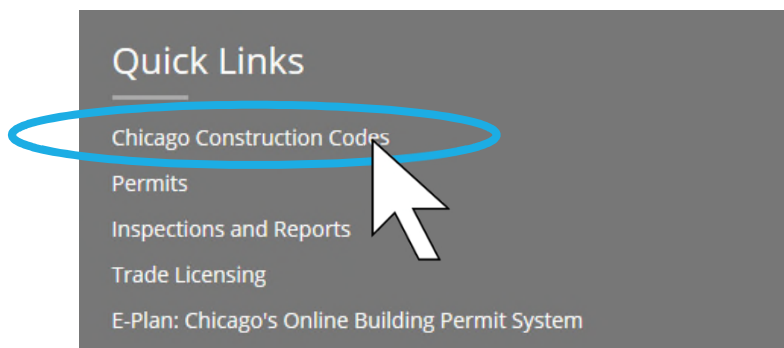

## Finding the New Codes (continued)



**Administrative Provisions of the Chicago Construction Codes (Title 14A)**  
View full text from ICC  
Purchase print or electronic copy from ICC  
Full text from American Legal Publishing



**Chicago Building Code (Title 14B)**  
View full text from ICC  
Purchase print or electronic copy from ICC  
Chicago Amendments from American Legal Publishing



**Chicago Conveyance Device Code (Title 14C)**  
Chicago Amendments from American Legal Publishing  
Links to purchase model codes

**Chicago Electrical Code (Title 14E)**  
View full text from NFPA  
Purchase print copy from NFPA  
Purchase electronic access from NFPA  
Chicago Amendments from American Legal Publishing

**INTERIM Chicago Fire Prevention Code (Title 14F)**  
Full text from American Legal Publishing

**INTERIM Chicago Fuel Gas Code (Title 14G)**  
Full text from American Legal Publishing



**INTERIM Chicago Mechanical Code (Title 14M)**  
Full text from American Legal Publishing

**Chicago Energy Conservation Code (Title 14N)**  
View full text from ICC  
Purchase print or electronic copy from ICC  
Chicago Amendments from American Legal Publishing



**INTERIM Chicago Plumbing Code (Title 14P)**  
Full text from American Legal Publishing

**Chicago Building Rehabilitation Code (Title 14R)**  
View full text from ICC  
Purchase print or electronic copy from ICC  
Chicago Amendments from American Legal Publishing



**Chicago Minimum Requirements for Existing Buildings (Title 14X)**  
View full text from ICC  
Purchase print or electronic copy from ICC  
Full text from American Legal Publishing



Purchase print or electronic Chicago Construction Codes bundle from ICC

## Finding the New Codes (continued)



Chicago Building Code (Title 14B)

[View full text from ICC](#)

[Purchase print or electronic copy from ICC](#)

[Chicago Amendments from American Legal Publishing](#)



CODE BOOK



## Margin Markings and Italics

**1207.3 Room area.** Every *dwelling unit* shall have at least one room that shall have not less than 120 square feet (11.2 m<sup>2</sup>) of *net floor area*. Dining spaces shall have a *net floor area* of not less than 60 square feet (5.6 m<sup>2</sup>). Other *habitable spaces* shall have a *net floor area* of not less than 70 square feet (6.5 m<sup>2</sup>). Where a single room is provided for cooking, dining and living purposes, it shall have a *net floor area* of not less than 180 square feet (16.7 m<sup>2</sup>).

> **1207.4 [Reserved]**

- Double line in margin indicates Chicago amendment to I-Code
- Carat in margin indicates Chicago deletion from I-Code
- Italic text indicates defined term (Definitions in Chapter 2)



## Chicago-specific Definitions

- **"Approved"** means approval outside the normal permitting process: ACAR, S&T, BBA (14A-2-202)
- **"Building official"** means the Building Commissioner or designee (14A-2-202)
- **"Deck", "exterior balcony" and "porch"** defined (14B-2-202)
- **"Occupiable rooftop"** defined (requirements in Ch. 15) (14B-2-202)
- **"Telecommunications equipment area"** replaces "technology center" (14B-2-202)



## Measurements (Sec. 203)

- Grade Plane
- Building Height
  - 7 exceptions
- Building Area
- Floor Area
  - Gross Floor Area (default)
  - Net Floor Area



**CODE BOOK**



# Building Code Appendices

- Appendix **D**: Fire Limits
- Appendix **E**: Supplementary Accessibility Requirements
- Appendix **S**: Optional Smoke Control Systems
- ICC A117.1-2009: *Accessible and Usable Buildings and Facilities* – reproduced at end of building code book

Con  
Cod

B

Title 14

CHICAGO  
BUILDING CODE

Based on the 2018 International Building Co

**REFERENCE**



# For More Information . . .

- *About the Chicago Construction Codes* at the front of each book
- *Effective use of the . . . Code* at the front of each book
- Other presentations and materials at:  
<http://www.chicago.gov/DOB>

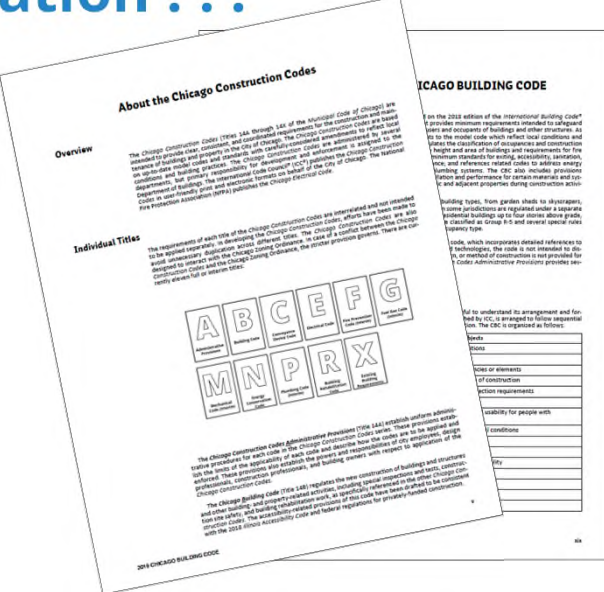

About the Chicago Construction Codes

Overview  
The Chicago Construction Codes (Titles 14A through 14E of the Municipal Code of Chicago) are intended to provide minimum requirements for the construction and maintenance of buildings and structures in the City of Chicago. The Chicago Construction Codes are administered by several departments and agencies. The Chicago Construction Codes are administered by several departments and agencies. The Chicago Construction Codes are administered by several departments and agencies.

Individual Titles  
The requirements of each title of the Chicago Construction Codes are interpreted and not intended to be applied in a uniform manner. The Chicago Construction Codes are administered by several departments and agencies. The Chicago Construction Codes are administered by several departments and agencies.

A	B	C	E	F	G
M	N	P	R	X	

The Chicago Building Code (Title 14B) regulates the construction of buildings and structures and other building and property-related activities, including general provisions and structural provisions. The Chicago Building Code (Title 14B) regulates the construction of buildings and structures and other building and property-related activities, including general provisions and structural provisions. The Chicago Building Code (Title 14B) regulates the construction of buildings and structures and other building and property-related activities, including general provisions and structural provisions.

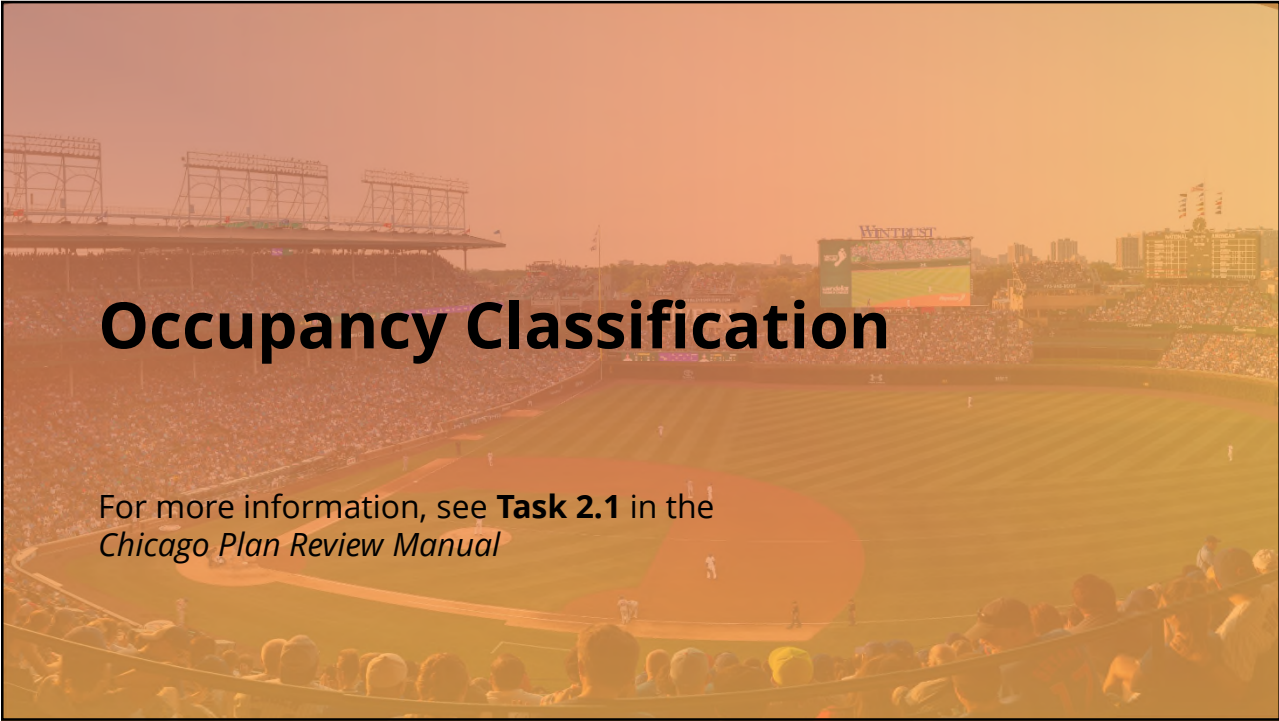

<b>A</b>	<b>Assembly:</b> gathering of persons for civic, social, or religious functions, recreation, food or drink consumption, or awaiting transportation	C-1/C-2, D
<b>B</b>	<b>Business:</b> office, professional, or service-type transactions, including storage of records and accounts	E
<b>E</b>	<b>Educational:</b> Educational purposes through the 12th grade or day care services for children*	C-3
<b>F</b>	<b>Factory/Industrial:</b> assembling, disassembling, fabricating, finishing, manufacturing, packaging, repair, or processing operations not in Group H (High-hazard) or S (Storage).	G

<b>H</b>	<b>High-hazard:</b> unusual risk of detonation, deflagration, combustion, toxicity or similar hazard.	I
<b>I</b>	<b>Institutional:</b> care or supervision is provided to persons who are not cable of self-preservation without assistance or in which liberty of occupants is restricted.	E
<b>M</b>	<b>Mercantile:</b> display and sale of merchandise, including stocks of goods, wares or merchandise incidental to such purposes	F
<b>R</b>	<b>Residential:</b> use of a building for sleeping purposes not classified as Group I (Institutional)	A

<b>S</b>	<b>Storage:</b> storage that is not classified as a Group H (high-hazard) occupancy, including parking motor vehicles.	H
<b>U</b>	<b>Utility/Miscellaneous:</b> buildings and structures of an accessory character and miscellaneous structures not classified in any occupancy.	J

## Group A-1

Self-cert limited to occupant load less than 300

### Examples

- Movie theaters
- Symphony and concert halls
- Television/radio studios (with audience)
- Theaters with stage performances

### Typical Features

- High occupant density
- Low or specialized lighting
- Scheduled performances
- Foyer
- Seating in rows



## Group A-2

Self-cert limited to occupant load less than 300

### Examples

- Banquet halls
- Casino (gaming area)
- Dance halls
- Nightclubs
- Restaurants, cafeterias
- Taverns and bars

### Typical Features

- On-site consumption of food or drink
- High occupant density

**Note:** Assembly-type occupancies with an occupant load *less than 50* are classified as Group B.



## Group A-3

Self-cert limited to occupant load less than 300

### Examples

- Courtrooms
- Funeral parlors
- Museums
- Places of religious worship
- Recreational centers
- Waiting areas (airport, bus, train)

### Typical Features

- Potential for high occupant density
- Significant areas of open floor space



## Group A-4

Self-cert limited to occupant load less than 300

### Examples

- Arenas
- Skating rinks
- Swimming pools
- Tennis courts

### Typical Features

- Indoor spectator seating
- Significant area of indoor floor space for athletic activities
- High occupant density





## Group A-5

Self-cert limited to occupant load less than 300

### Examples

- Amusement parks
- Bleachers
- Drive-in theaters
- Fairgrounds
- Racetracks
- Stadiums

### Typical Features

- Outdoor activities
- High occupant density

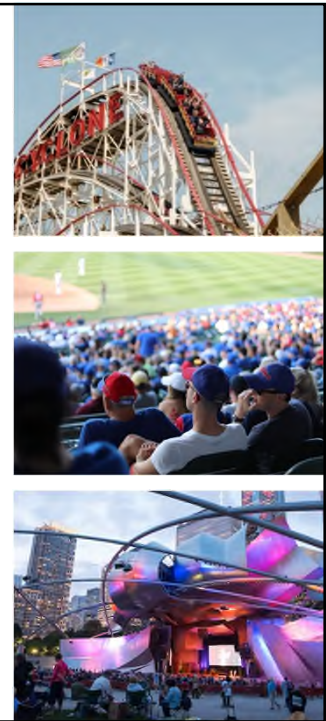

## Group B

### Examples

- Banks
- Car washes
- Dry cleaning
- Adult education (students above grade 12)
- Food processing/ commercial kitchen
- Laboratories (testing and research)

- Post offices
- Professional services (architects, attorneys, dentists, physicians, engineers, etc.)
- Radio and television stations

**Note:** Assembly-type occupancies with an occupant load *less than 50* are classified as Group B.

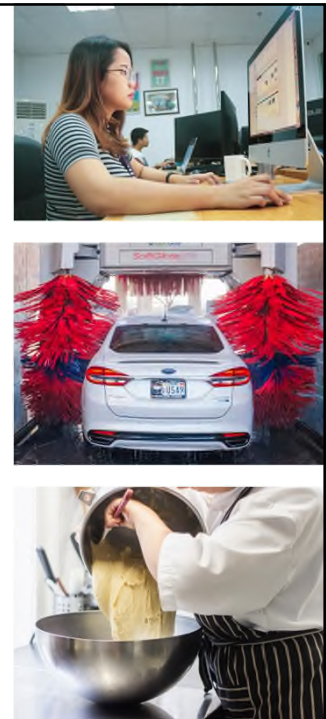



## Telecommunications Equipment Area

**Self-cert  
limited to  
150 ft<sup>2</sup>**

An area or enclosed room within a building where electronic equipment used for the transmission of audio, video and data, power equipment (e.g., dc converters, inverters and batteries), technical support equipment (e.g., computers), and conductors dedicated solely to the operation of the equipment are located, including support rooms served by the same ventilation system.

- Server room
- Data center



KEY CONCEPT



## Ambulatory Care Facility

**Self-cert  
prohibited**

Buildings used to provide medical, surgical, psychiatric, nursing or similar care on a less than 24-hour basis to persons who are rendered incapable of self-preservation by the services provided or staff has accepted responsibility for care recipients already incapable.

- Day surgery centers
- Dialysis centers
- Dentists with anesthesia



# Group E

## Group E-1

- Preschools
- Elementary schools
- Junior high schools
- High schools

Self-cert limited to alterations/repairs

## Group E-2

- Child day care facilities\*

Self-cert prohibited



# Group F

Self-cert prohibited

assembling, disassembling, fabricating, finishing, manufacturing, packaging, repair, or processing operations not in Group H (High-hazard) or S (Storage).

## Examples

- Automobiles
- Bakeries
- Beverages
- Clothing
- Dry cleaning/ laundries
- Electronics
- Furniture
- Machinery
- Motion picture/TV studios
- Recycling plants
- Woodworking

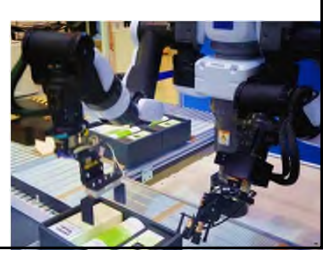

## Group H

**Self-cert prohibited**

**H-1:** Detonation Hazard

**H-2:** Deflagration or Accelerated Burning Hazard

**H-3:** Combustion or Physical Hazard

**H-4:** Health Hazard

**H-5:** Semiconductor Fabrication



## Group I

**Self-cert prohibited**

care or supervision is provided to persons who are not cable of self-preservation without assistance or in which liberty of occupants is restricted.

**I-1:** Non-medical care

**I-2:** Medical or nursing care

**I-3:** Detention/correctional facilities

**I-4:** Institutional day care



# Group M

**Self-cert limited to 30,000 ft<sup>2</sup>**

## Examples

- Department stores
- Drug stores
- Greenhouses
- Gas stations
- Retail and wholesale stores
- Supermarkets

**Note:** Food service establishments with an occupant load less than 50 will be classified as Group B.

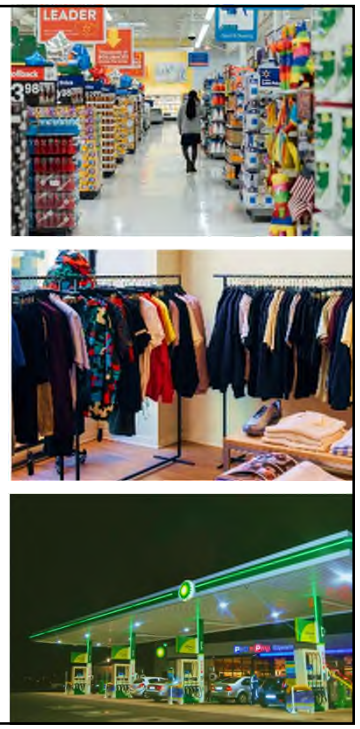

# Group R-1

## Examples

- Hotels with accommodations for > 10 transient occupants
- Temporary overnight shelters
- Congregate living facilities with accommodations for > 10 transient occupants

**Self-cert prohibited for congregate living facilities**



# Group R-2

## Examples

- Apartments
- Dormitories
- Live/work units (Section 419)

**Self-cert prohibited for congregate living facilities**

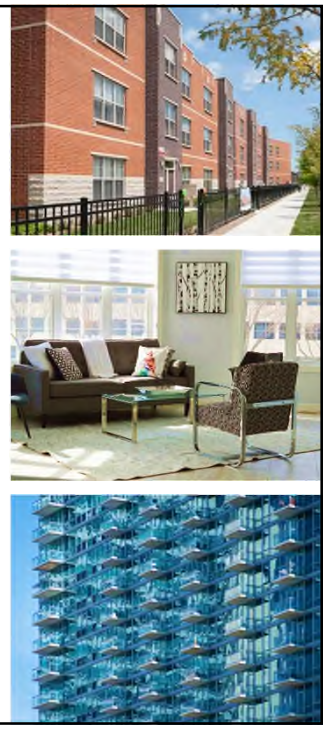

# Group R-3

## Examples

- Bed-and-breakfast establishments
- Care facilities that provide accommodations for 5 or fewer individuals receiving care
- Hotels with accommodations for 10 or fewer transient occupants
- Congregate living facilities (nontransient), such as a fraternity house, sorority house, convent, or monastery, ≤ 16 occupants

**Self-cert prohibited for congregate living facilities**



# Group R-4

Care facilities that provide accommodations for 6 to 16 individuals receiving care, including:

- Alcohol and drug centers
- Assisted living facilities
- Congregate care facilities
- Group home
- Halfway houses
- Rehabilitation facilities

**Self-cert prohibited for congregate living facilities**



# Group R-5

## Examples:

- Detached single-family homes
- Two-flats
- Three-flats
- Attached single-family homes (up to 3)
- Associated private garages and accessory structures

**Self-cert prohibited for congregate living facilities**





# Group R-5

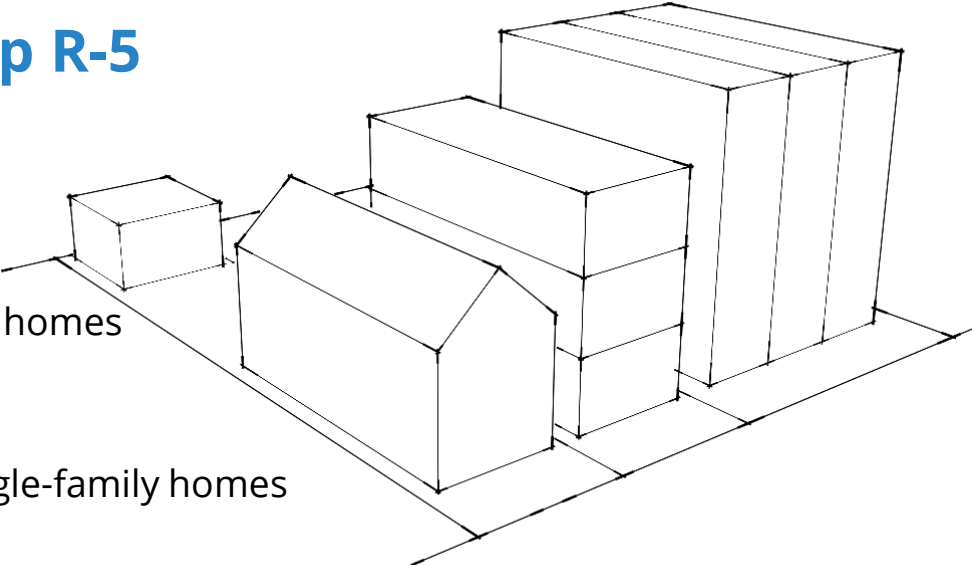

**Examples:**

- Detached single-family homes
- Two-flats
- Three-flats
- Attached single-family homes (up to 3)
- Associated private garages and accessory structures

# Group S

**Self-cert prohibited**

**Examples**

- Aerosol products-level 2 and 3
- Aircraft hangars
- Dry boat storage (indoor)
- Food product storage
- Glass storage
- Metal storage
- Motor vehicle repair garages
- Parking garages
- Pottery storage
- Self-service storage facilities (mini-storage)
- Textile/clothing storage
- Tires, bulk storage





## Group U

Consult DOB prior  
to self-cert

### Examples

- Agricultural buildings
- Greenhouses
- Lumber yards (exterior)
- Parking facilities
- Private garages and carports (except accessory to Group R-5)
- Stables



KEY CONCEPT



## Mixed Occupancies

Many buildings contain more than one occupancy. Three strategies for dealing with mixed occupancy:

- **Separated mixed occupancy**
  - Traditional approach
  - Fire-resistance-rated separations (Table 508.4)
- **Unseparated mixed occupancy**
  - Design for the worst case
- **Accessory occupancy** (replaces “auxiliary uses”)

## Mixed Occupancies (continued)

There are special separation rules for:

- **Group H** occupancies must always be separated.
- **Parking** and motor-vehicle related occupancies per Sec. 406.
- **Dwelling Units** and **Sleeping Units** require 1-hour per Sec. 420.
- **“Large” Assembly** (occupant load  $\geq 300$ ) 1-hour in fully-sprinklered building and 2-hours in nonsprinklered building per Sec. 508.3.3.

KEY CONCEPT



## Accessory Occupancies

- Accessory occupancies are classified per Ch. 3
  - Classification is **used** for determining means of egress and fire protection requirements (Chs. 9 & 10)
  - Classification is **ignored** for height and area determination (Ch. 5)
- Necessary to support main occupancy
- Aggregate of accessory occupancies limited to 25% floor area of story, and 5% total floor area of main occupancy
- Floor area of accessory occupancy limited to max. area for that occupancy class in nonsprinklered building

## Accessory Occupancies (continued)

Special rules for:

- Accessory assembly-type use, OL < 50 or area < 750 ft<sup>2</sup> (303.1.2)
- Accessory classroom(s) (305.2, Exception)
- Accessory child daycare (305.3, Exception)
- Accessory storage (311.1.1)

KEY CONCEPT



### Incidental Uses

- Incidental uses are areas which create additional hazards
- Not classified as separate occupancies
- Limited to 10% of floor area of primary occupancy
- Must be separated/protected as provided in Table 509

## Types of Construction

For more information, see **Task 2.2** in the *Chicago Plan Review Manual*

KEY CONCEPT



### Construction Type Basics

- Construction type classification is based on the combustibility and fire-resistance of the materials and assemblies used.
- More fire-resistive construction types are required for larger buildings and occupancy types with a greater risk of fire.
- **Under the *Chicago Building Code*, a building can only have one construction type.**

CODE BOOK



# Combustible vs. Noncombustible

- A building material is “noncombustible” if it has been tested to show:
  - It is a solid (elemental) material that meets performance criteria after being placed in a 1382 °F for 30 minutes per ASTM E136
  - It is a composite material with a base of solid material that passes the ASTM E136 test plus a surfacing not more than 1/8-inch thick that has a flame spread index  $\leq 50$
- Any non-tested material is classified as combustible.



KEY CONCEPT



# Protected vs. Unprotected

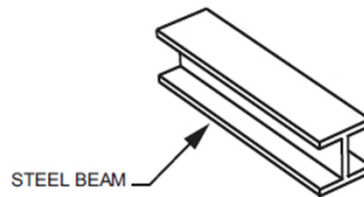
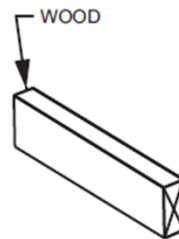
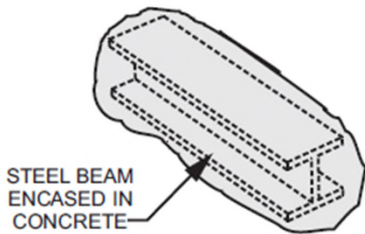
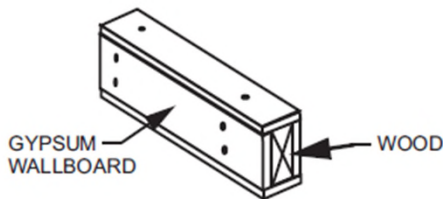



# Fire-resistance Rating for Building Elements (Table 601)

**TABLE 601  
FIRE-RESISTANCE RATING REQUIREMENTS FOR BUILDING ELEMENTS (HOURS)**

BUILDING ELEMENT	TYPE I		TYPE II		TYPE III		TYPE IV	TYPE V	
	A	B	A	B	A	B	HT	A	B
<i>Primary structural frame<sup>f</sup></i>	3 <sup>a,b</sup>	2 <sup>a,b</sup>	1 <sup>b</sup>	0	1 <sup>b</sup>	0	HT	1 <sup>b</sup>	0
Bearing walls									
Exterior <sup>e,f</sup>	3	2	1	0	2	2	2	1	0
Interior	3 <sup>a</sup>	2 <sup>a</sup>	1	0	1	0	1/HT	1	0
Nonbearing walls and partitions — Exterior	See Table 602								
Nonbearing walls and partitions — Interior <sup>d</sup>	0	0	0	0	0	0	Note i	0	0
Floor construction and associated <i>secondary members</i>	2	2	1	0	1 <sup>g</sup>	0	HT	1 <sup>g</sup>	0
Roof construction and associated <i>secondary members</i>	1.5 <sup>b</sup>	1 <sup>b</sup>	1 <sup>b</sup>	0 <sup>c</sup>	1 <sup>b,c,h</sup>	0	HT	1 <sup>b,c,h</sup>	0

- For SI: 1 foot = 304.8 mm.
- a. Roof supports: *Fire-resistance ratings of primary structural frame* and bearing walls are permitted to be reduced by 1 hour where supporting a roof only.
  - b. Except in Group F-1, H, M and S-1 occupancies, fire protection of structural members in roof construction shall not be required, including protection of *primary structural frame* members, roof framing and decking where every part of the roof construction is 20 feet or more above any floor immediately below.
  - c. In all occupancies, heavy timber complying with Section 2304.11 shall be allowed where a 1-hour or less *fire-resistance rating* is required.
  - d. Not less than the *fire-resistance rating* required by other sections of this code.
  - e. Not less than the *fire-resistance rating* based on *fire separation distance* (see Table 602).
  - f. Not less than the *fire-resistance rating* as referenced in Section 704.10.
  - g. In single-family dwellings, the floor construction over *basements* and unexcavated spaces below the first *story above grade plane* is not required to have a *fire-resistance rating*.
  - h. In buildings of exclusively Group R-2, R-3, R-4 or R-5 occupancy with no more than four *stories above grade plane*, the required *fire-resistance rating* of roof construction and associated secondary members shall be reduced to 30 minutes.
  - i. See Section 2304.11.2.



# Fire-resistance Rating for Building Elements (Table 601)

**TABLE 601  
FIRE-RESISTANCE RATING REQUIREMENTS FOR BUILDING ELEMENTS (HOURS)**

BUILDING ELEMENT	TYPE I		TYPE II		TYPE III		TYPE IV
	A	B	A	B	A	B	HT
<i>Primary structural frame<sup>f</sup></i>	3 <sup>a,b</sup>	2 <sup>a,b</sup>	1 <sup>b</sup>	0	1 <sup>b</sup>	0	HT
Bearing walls							
Exterior <sup>e,f</sup>	3	2	1	0	2	2	2
Interior	3 <sup>a</sup>	2 <sup>a</sup>	1	0	1	0	1/HT
Nonbearing walls and partitions — Exterior	See Table 602						
Nonbearing walls and partitions — Interior <sup>d</sup>	0	0	0	0	0	0	Note i
Floor construction and associated <i>secondary members</i>	2	2	1	0	1 <sup>g</sup>	0	HT
Roof construction and associated <i>secondary members</i>	1.5 <sup>b</sup>	1 <sup>b</sup>	1 <sup>b</sup>	0 <sup>c</sup>	1 <sup>b,c,h</sup>	0	HT

CODE BOOK



# Fire-resistance Rating for Building Elements (Table 601)

**TABLE 601  
FIRE-RESISTANCE RATING REQUIREMENTS FOR BUILDING ELEMENTS (HOURS)**

BUILDING ELEMENT	TYPE I		TYPE II		TYPE III		TYPE IV
	A	B	A	B	A	B	HT
Primary structural frame <sup>f</sup>	3 <sup>a, b</sup>	2 <sup>a, b</sup>	1 <sup>b</sup>	0	1 <sup>b</sup>	0	HT
Bearing walls							
Exterior <sup>c, f</sup>	3	2	1	0	2	2	2
Interior	3 <sup>a</sup>	2 <sup>a</sup>	1	0	1	0	1/HT
Nonbearing walls and partitions — Exterior	See Table 602						
Nonbearing walls and partitions — Interior <sup>d</sup>	0	0	0	0	0	0	Note i
Floor construction and associated secondary members	2	2	1	0	1 <sup>e</sup>	0	HT
Roof construction and associated secondary members	1.5 <sup>b</sup>	1 <sup>b</sup>	1 <sup>b</sup>	0 <sup>c</sup>	1 <sup>b, c, h</sup>	0	HT

KEY CONCEPT



# Fire-resistance Rating for Exterior Walls (Table 602)

**TABLE 602  
FIRE-RESISTANCE RATING REQUIREMENTS FOR EXTERIOR WALLS BASED ON FIRE SEPARATION DISTANCE<sup>a, 9</sup>**

FIRE SEPARATION DISTANCE = X (feet)	TYPE OF CONSTRUCTION	OCCUPANCY GROUP H <sup>e</sup>	OCCUPANCY GROUP F, S <sup>f</sup>	OCCUPANCY GROUP A, B, E, M, I, R, U <sup>g</sup>
X < 3 <sup>b</sup>	VA, VB	NP	NP	2 <sup>h, j</sup>
	Others	3	2	2
3 ≤ X < 5	All	3	2	1
5 ≤ X < 10	IA	3	2	1
	Others	2	1	1
10 ≤ X < 30	IA, IB	2	1 <sup>k</sup>	1 <sup>c, k</sup>
	IIB, VB	1	0	0
	Others	1	1 <sup>k</sup>	1 <sup>c, k</sup>
X ≥ 30	All	0	0	0

For SI: 1 foot = 304.8 mm.

a. Load-bearing exterior walls shall also comply with the fire-resistance rating requirements of Table 601.

b. See Section 706.1.1 for party walls.

c. Open parking garages complying with Section 406 shall not be required to have a fire-resistance rating.

d. The fire-resistance rating of an exterior wall is determined based upon the fire separation distance of the exterior wall and the story in which the wall is located.

e. For special requirements for Group H occupancies, see Section 415.6.

f. For special requirements for Group S aircraft hangars, see Section 412.3.1.

g. Where Table 705.8 permits nonbearing exterior walls with unlimited area of unprotected openings, the required fire-resistance rating for the exterior walls is 0 hours.

h. A single-story detached private garage, carport or storage building not exceeding 600 square feet (56 m<sup>2</sup>) in building area, not exceeding 12 feet (3658 mm) in building height and with a roof slope of 2:12 or greater shall be permitted in Type VA or Type VB construction when the fire separation distance is 2 feet (610 mm) or greater and the exterior wall shall not be required to have a fire-resistance rating.

i. [Reserved]

j. Any exterior wall with a fire separation distance of less than 3 feet shall have a fire-resistance rating of not less than 2 hours and shall be built of noncombustible materials, materials allowed by Section 603 or fire-retardant treated wood framing complying with Section 2303.2 with a noncombustible exterior wall covering.

k. The required fire-resistance rating of exterior walls with a fire separation distance of 10 feet or greater shall only be required to be rated for exposure to fire from the inside in accordance with Section 705.5.

# Type I Construction

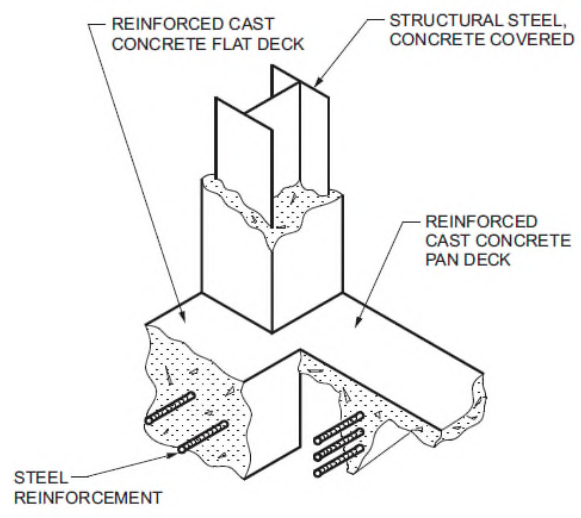

# Type I Construction (continued)

Fire-Resistance Ratings in Table 601		
	Type IA	Type IB
Primary Structural Frame	3	2
Exterior Bearing Walls	3	2*
Interior Bearing Walls	3	2
Floor Construction	2	2
Roof Construction	1.5	1

\*not less than the rating based on fire separation distance (see Table 602)



# Type II Construction

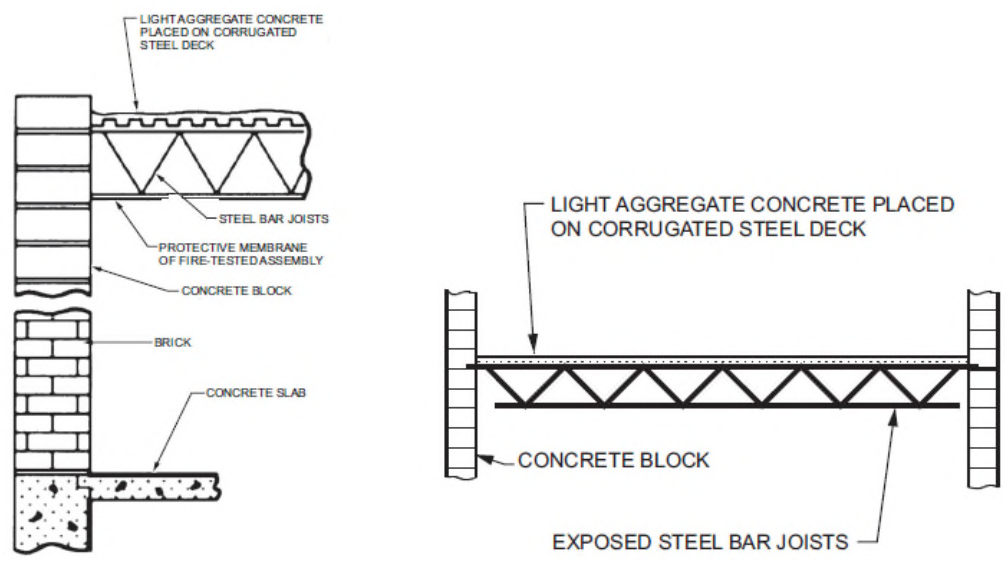

# Type II Construction (continued)

Fire-Resistance Ratings in Table 601		
	Type IIA	Type IIB
Primary Structural Frame	1	0
Exterior Bearing Walls	1*	0*
Interior Bearing Walls	1	0
Floor Construction	1	0
Roof Construction	1	0

\*not less than the rating based on fire separation distance (see Table 602)

# Type III Construction

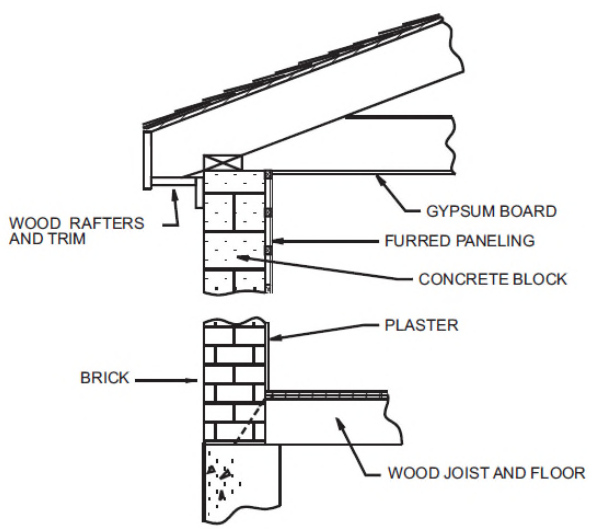

# Type III Construction (continued)

**Fire-Resistance Ratings in Table 601**

	Type IIIA	Type IIIB
Primary Structural Frame		
Exterior Bearing Walls		
Interior Bearing Walls		
Floor Construction		
Roof Construction		

\*not less than the rating based on fire separation distance (see Table 602)

\*\* For nontransient residential bldgs. up to 4 stories, may be reduced to 30 min. (note h)

## Type III Construction (continued)

Fire-Resistance Ratings in Table 601		
	Type IIIA	Type IIIB
Primary Structural Frame	1	0
Exterior Bearing Walls	2*	2*
Interior Bearing Walls	1	0
Floor Construction	1	0
Roof Construction	1**	0

\*not less than the rating based on fire separation distance (see Table 602)

\*\* For nontransient residential bldgs. up to 4 stories, may be reduced to 30 min.

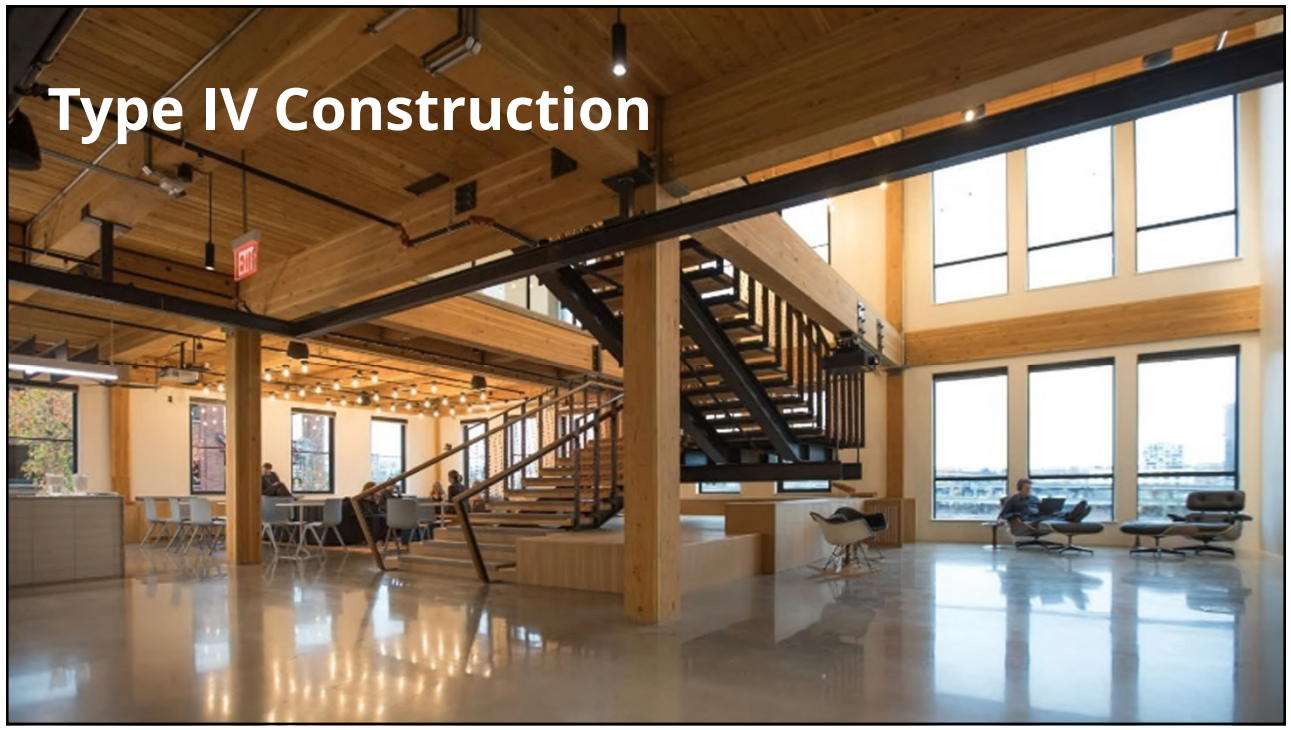

## Type IV Construction

## Type IV Construction (continued)

Fire-Resistance Ratings in Table 601	
	Type IV (HT)
Primary Structural Frame	HT
Exterior Bearing Walls	2*
Interior Bearing Walls	1/HT
Floor Construction	HT
Roof Construction	HT

\*not less than the rating based on fire separation distance (see Table 602)



## Type V Construction (continued)

### Fire-Resistance Ratings in Table 601

	Type VA	Type VB
Primary Structural Frame		
Exterior Bearing Walls		
Interior Bearing Walls		
Floor Construction		
Roof Construction		

\*not less than the rating/materials based on fire separation distance (see Table 602)  
 \*\* For nontransient residential bldgs. up to 4 stories, may be reduced to 30 min.

## Type V Construction (continued)

### Fire-Resistance Ratings in Table 601

	Type VA	Type VB
Primary Structural Frame	1	0
Exterior Bearing Walls	1*	0*
Interior Bearing Walls	1	0
Floor Construction	1	0
Roof Construction	1**	0

\*not less than the rating/materials based on fire separation distance (see Table 602)  
 \*\* For nontransient residential bldgs. up to 4 stories, may be reduced to 30 min.



# Type V Construction (continued)

- For exterior walls of Type V construction that are closer than 3 feet to an interior property line there are 2 options (Table 602, note j):
  - Noncombustible materials/materials allowed in noncombustible walls
  - Fire-retardant treated wood framing with a noncombustible exterior wall covering (e.g. fiber cement)



American Wood Council, Design for Code Acceptance (DCA3), July 2019

## Combustible Materials in Noncombustible Construction (603, 604)

- Sections 603 and 604 make limited exceptions for allowing combustible materials in Types I and II construction and in the exterior walls of Types III and IV construction.
- Exceptions include insulation, finish flooring, doors, windows, and trim.
- A summary of these allowances is on p. I-80 of the *Manual*.



## Basement Construction (Sec. 605)

- Because below-grade basements are more difficult to access for firefighting, additional requirements apply to basement construction for all construction types.
  - Buildings with 3+ stories above grade require basement columns and bearing walls of noncombustible or HT materials
  - Buildings with multiple basements require Type IA construction for floor of first story above grade and everything below
  - Except for Group R-5, 1-hour floor construction is required over basements
- Additional requirements apply to “underground buildings” (Sec. 405)

## Height and Area Limitations

For more information, see **Tasks 2.3, 2.4, and 2.5** in the *Chicago Plan Review Manual*

**KEY CONCEPT**

# Height and Area

- 1 Building Height
- 2 Building Area—Single Occupancy
- 3 Building Area—Separated Mixed Occupancy



**KEY CONCEPT**

# Grade Plane

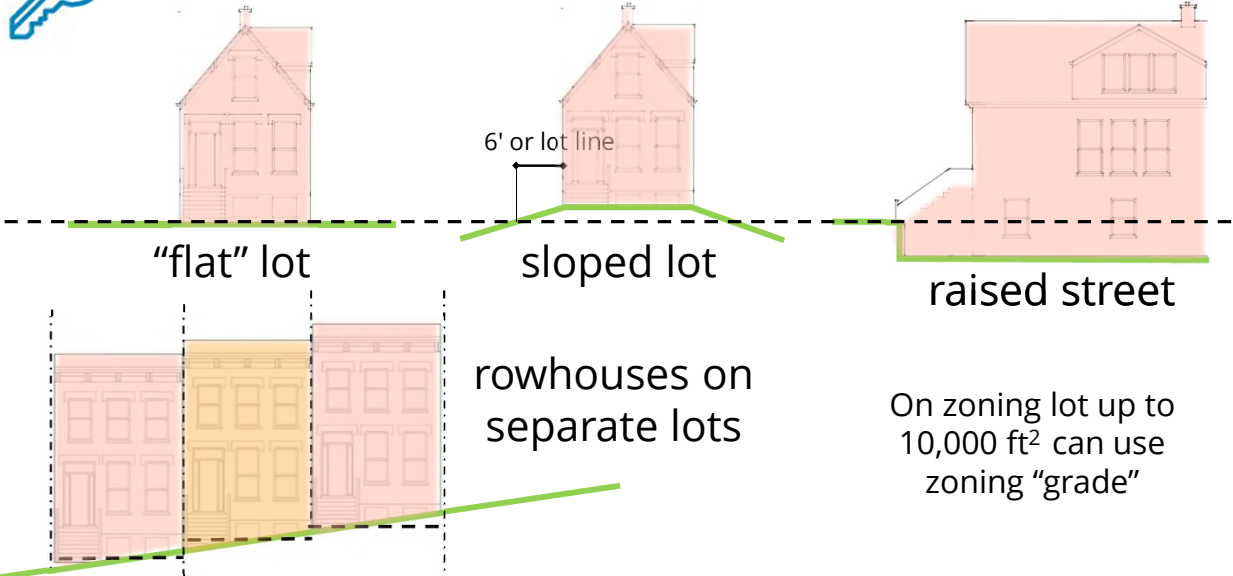

“flat” lot

sloped lot

6' or lot line

raised street

rowhouses on separate lots

On zoning lot up to 10,000 ft<sup>2</sup> can use zoning “grade”



KEY CONCEPT



## Building Height

- Vertical distance from grade plane to the mean elevation of the highest roof plane.
  - ≠ zoning height
  - ≠ mean roof height (structural)
- 7 exceptions to deal with occupiable rooftops, parapet walls, mechanical penthouses, certain dormers, above-deck continuous insulation ([Sec. 203.3, Exceptions](#))

## Building Height (continued)

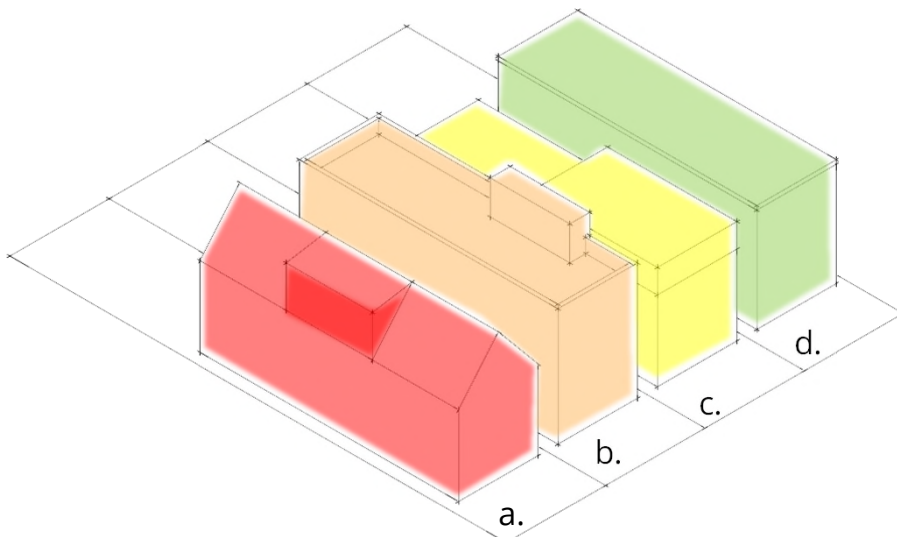

KEY CONCEPT



# Stories vs. Stories Above Grade Plane

• **STORY.** That portion of a *building* included between the upper surface of a floor and the upper surface of the floor or roof next above.

- Story above grade plane
- Basement
- Attic (sometimes)

Not a story (if requirements met):

- Mezzanine
- Occupiable rooftop

## Stories Above Grade Plane

Any *story* having its finished floor surface entirely above *grade plane*, or in which the finished surface of the floor next above is:

1. More than 6 feet above *grade plane*.
2. More than 12 feet above the adjacent finished ground level at any point.

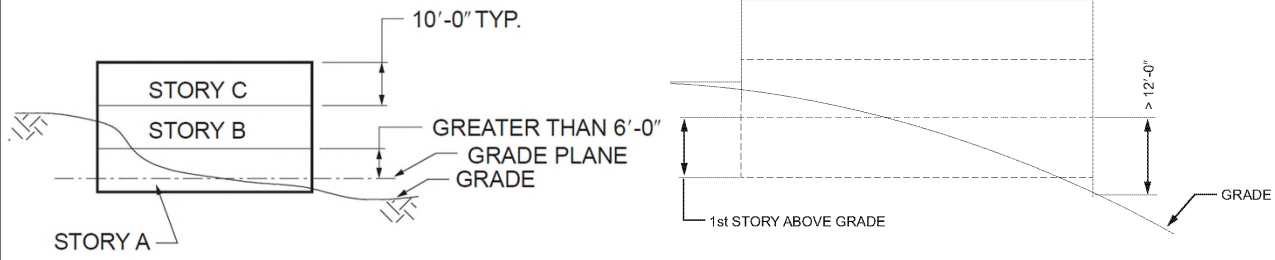



## Lofts, Mezzanines, and Equipment Platforms

- **LOFT.** A floor level located above the main floor level within a *dwelling unit* or *sleeping unit*, open to the main floor on at least one side and used as a living or sleeping space.
- **MEZZANINE.** An intermediate level or levels between the floor and ceiling of any *story* and in accordance with Section 505.
- **EQUIPMENT PLATFORM.** An unoccupied, elevated platform used exclusively for mechanical systems or industrial process equipment, including the associated elevated walkways, stairways, alternating tread devices and ladders necessary to access the platform (see Section 505.3).

FOR EXAMPLE



# Determining Height for Office Building (p. I-93)

- Office building (Group B)
- NFPA 13 sprinkler system (full)
- Type IIA construction
- Penthouse contains mechanical equipment, stairway and elevator serving roof

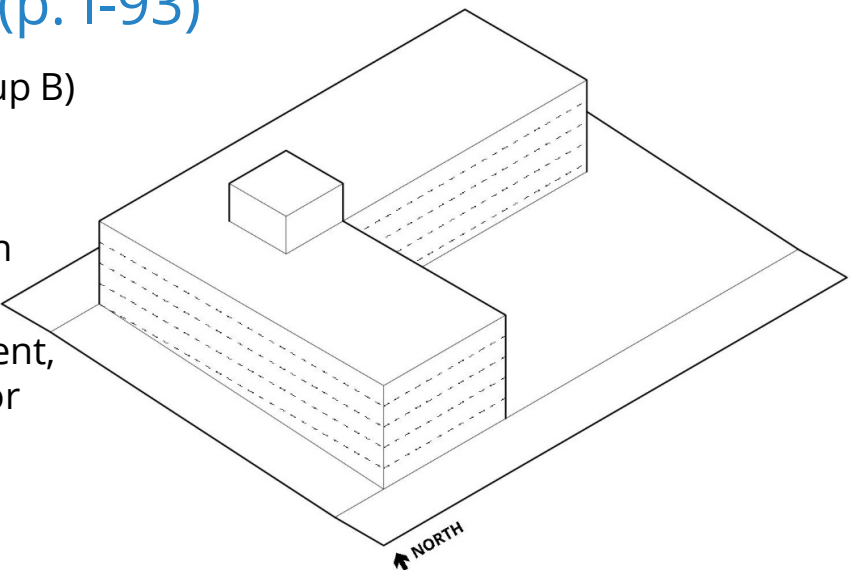

Manual p. I-94

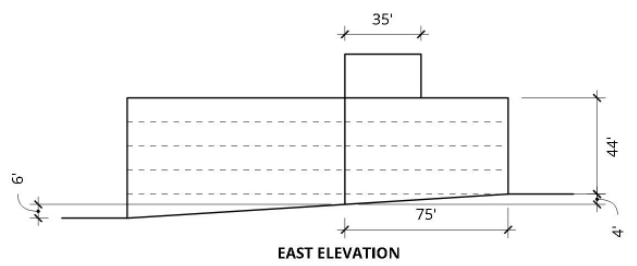
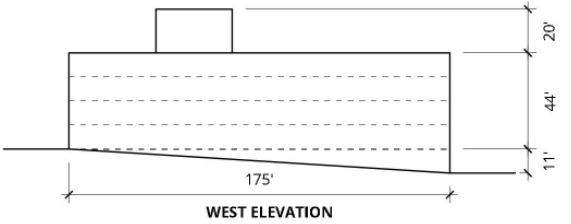
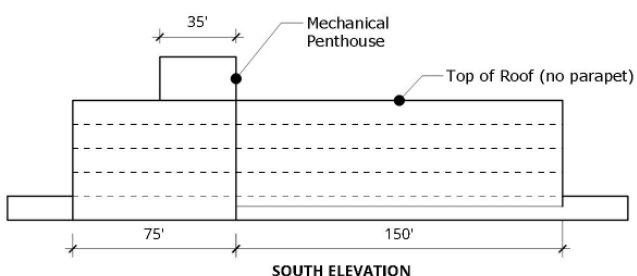
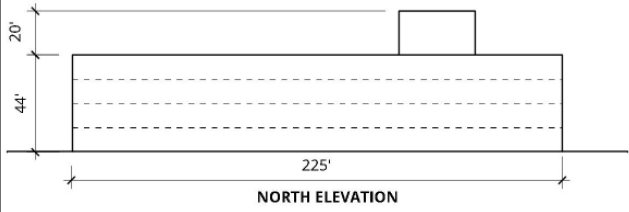

\* Wall height dimensions shown are taken from lowest point within 6'-0" horizontally from base of wall to average height of roof.

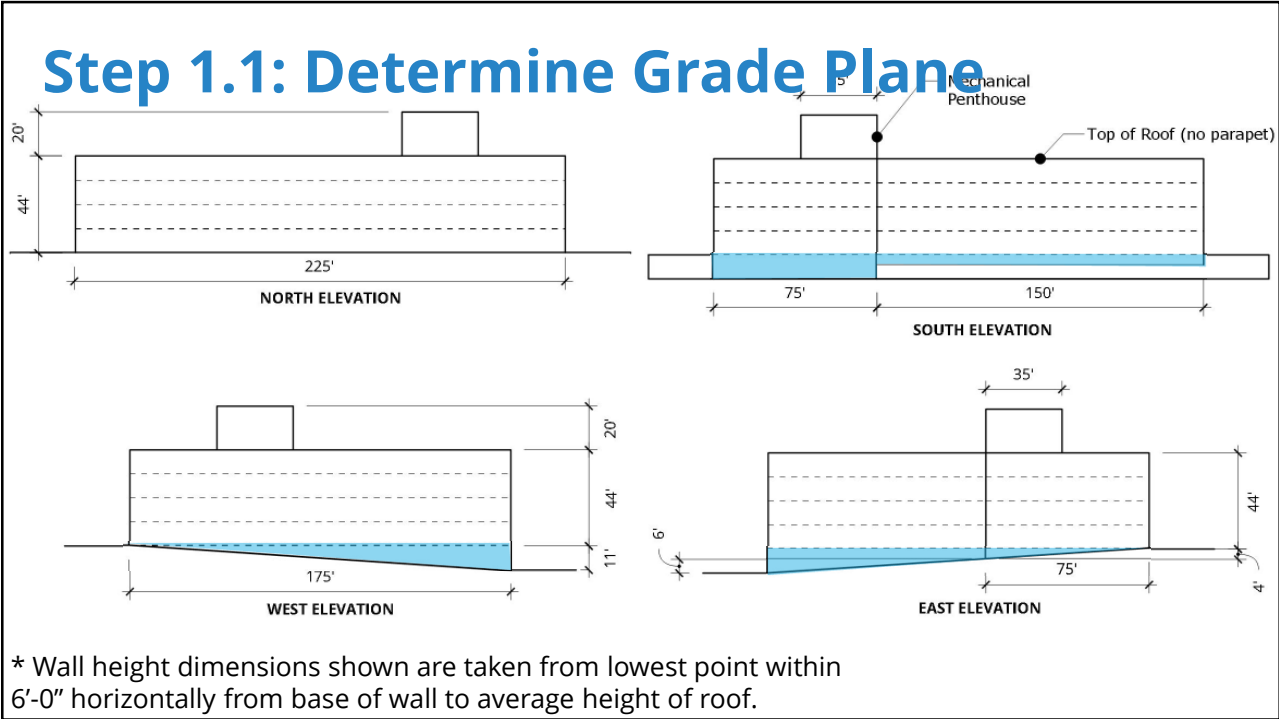

## Step 1.1: Determine Grade Plane (continued)

Calculate the above-ground area of each wall between the highest and lowest ground elevations adjoining the building:

North:	$0 \text{ ft} \times 225 \text{ ft} = 0 \text{ ft}^2$
West:	$11 \text{ ft} \times 175 \text{ ft} \div 2 = 962.5 \text{ ft}^2$
South:	$11 \text{ ft} \times 75 \text{ ft} + 4 \text{ ft} \times 150 \text{ ft} = 1,425 \text{ ft}^2$
East:	$11 \text{ ft} \times 175 \text{ ft} \div 2 = 962.5 \text{ ft}^2$
<b>Total:</b>	$0 \text{ ft}^2 + 962.5 \text{ ft}^2 + 1,425 \text{ ft}^2 + 962.5 \text{ ft}^2 = \mathbf{3,350 \text{ ft}^2}$

## Step 1.1: Determine Grade Plane (continued)

To find the vertical distance between the highest point and grade plane, divide the total wall area by the building perimeter.

Here, the building perimeter is:

$$225 \text{ ft} + 175 \text{ ft} + 75 \text{ ft} + 100 \text{ ft} + 150 \text{ ft} + 75 \text{ ft} = 800 \text{ ft}$$

$$3,350 \text{ ft}^2 \div 800 \text{ ft} = 4.2 \text{ ft}$$

## Step 1.1: Determine Grade Plane (continued)

Grade plane is **4.2 feet below** the highest ground level adjoining the building (here, the ground level adjoining the north wall.)

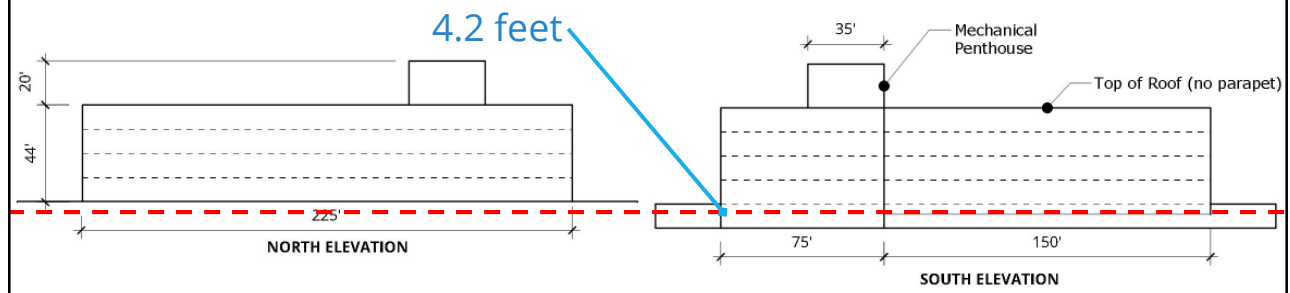

## Step 1.2: Determine Height in Feet

- Vertical distance from grade plane to main roof = 48.2 ft
- Vertical distance from grade plane to penthouse roof = 68.2 ft
- Mechanical penthouse is 5% of roof area (Sec. 1510.1.1)
- Mechanical/elevator penthouse height OK (Sec. 1510.2)
- **Building height = 48.2 ft**

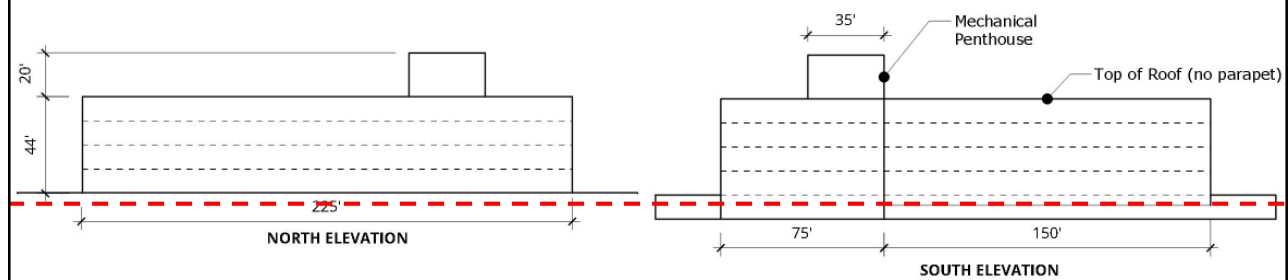

## Step 1.3: Determine Stories Above Grade

- Mechanical/rooftop access penthouse is not a story.
- Floor level of second story is 4.2 feet above grade plane.
- Floor level of second story is 11 feet above ground at SW corner (lowest point).
- Lowest story is basement.
- **Building height = 4 stories above grade plane**

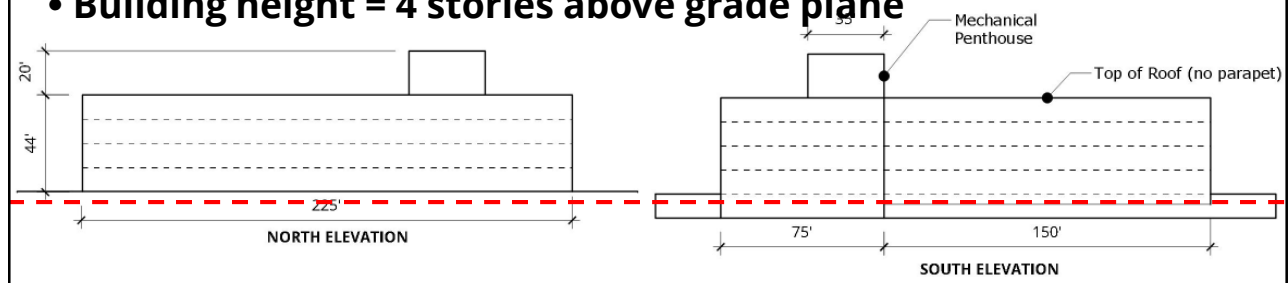

## Step 2.1: Allowable Bldg. Height in Feet

**TABLE 504.3  
ALLOWABLE BUILDING HEIGHT IN FEET ABOVE GRADE PLANE<sup>a</sup>**

OCCUPANCY CLASSIFICATION	TYPE OF CONSTRUCTION									
	SEE FOOTNOTES	TYPE I		TYPE II		TYPE III		TYPE IV	TYPE V	
		A	B	A	B	A	B	HT	A	B
A, B, E, F, H-4 <sup>c</sup> M, S, U	NS <sup>b</sup>	80	80	65	30	55	30	65	30	15
	S	UL	150	85	45	70	45	85 <sup>g</sup>	45	30
H-1, H-2, H-3, H-5	NS <sup>c, d</sup>	UL	80	65	30	55	NP	65	NP	NP
	S									
I	NS <sup>b</sup>	80	80	65	30	55	30	65	30	NP
	S	UL	150	85						
R	NS <sup>b</sup>	80	80	65	30	55	30	65	30 <sup>e</sup>	20
	S13D	40	40	40	40	40	40	40	40	35
	S13R	55	55	55	45	55	45	55	45 <sup>f</sup>	35
	S	UL	150	85	45	70	45	85 <sup>g</sup>	45 <sup>f</sup>	35

For SI: 1 foot = 304.8 mm.

UL = Unlimited; NS = Buildings not equipped throughout with an automatic sprinkler system; S = Buildings equipped throughout with an automatic sprinkler system installed in accordance with Section 903.3.1.1; S13R = Buildings equipped throughout with an automatic sprinkler system installed in accordance with Section 903.3.1.2; S13D = Buildings equipped throughout with an automatic sprinkler system installed in accordance with Section 903.3.1.3.

a. See Chapters 4 and 5 for specific exceptions to the allowable building height in this chapter.

## Step 2.1: Allowable Bldg. Height in Feet (continued)

**TABLE 504.3  
ALLOWABLE BUILDING HEIGHT IN FEET ABOVE GRADE PLANE<sup>a</sup>**

OCCUPANCY CLASSIFICATION	TYPE OF CONSTRUCTION									
	SEE FOOTNOTES	TYPE I		TYPE II		TYPE III		TYPE IV	TYPE V	
		A	B	A	B	A	B	HT	A	B
A, B, E, F, H-4 <sup>c</sup> M, S, U	NS <sup>b</sup>	80	80	65	30	55	30	65	30	15
	S	UL	150	85	45	70	45	85 <sup>g</sup>	45	30
H-1, H-2, H-3, H-5	NS <sup>c, d</sup>	UL	80	65	30	55	NP	65	NP	NP
	S									
I	NS <sup>b</sup>	80	80	65	30	55	30	65	30	NP
	S	UL	150	85						
R	NS <sup>b</sup>	80	80	65	30	55	30	65	30 <sup>e</sup>	20
	S13D	40	40	40	40	40	40	40	40	35
	S13R	55	55	55	45	55	45	55	45 <sup>f</sup>	35
	S	UL	150	85	45	70	45	85 <sup>g</sup>	45 <sup>f</sup>	35

For SI: 1 foot = 304.8 mm.

UL = Unlimited; NS = Buildings not equipped throughout with an automatic sprinkler system; S = Buildings equipped throughout with an automatic sprinkler system installed in accordance with Section 903.3.1.1; S13R = Buildings equipped throughout with an automatic sprinkler system installed in accordance with Section 903.3.1.2; S13D = Buildings equipped throughout with an automatic sprinkler system installed in accordance with Section 903.3.1.3.

a. See Chapters 4 and 5 for specific exceptions to the allowable building height in this chapter.



## Step 2.1: Allowable Bldg. Height in Feet (continued)

**TABLE 504.3**  
**ALLOWABLE BUILDING HEIGHT IN FEET ABOVE GRADE PLANE<sup>a</sup>**

OCCUPANCY CLASSIFICATION	SEE FOOTNOTES	TYPE OF CONSTRUCTION								
		TYPE I		TYPE II		TYPE III		TYPE IV	TYPE V	
		A	B	A	B	A	B	HT	A	B
A, B, E, F, H-4 <sup>c</sup> M, S, U	NS <sup>b</sup>	80	80	65	30	55	30	65	30	15
	S	UL	150	85	45	70	45	85 <sup>g</sup>	45	30
H-1, H-2, H-3, H-5	NS <sup>c, d</sup>	UL	80	65	30	55	NP	65	NP	NP
	S									
I	NS <sup>b</sup>	80	80	65	30	55	30	65	30	NP
	S	UL	150	85						
R	NS <sup>b</sup>	80	80	65	30	55	30	65	30 <sup>e</sup>	20
	S13D	40	40	40	40	40	40	40	40	35
	S13R	55	55	55	45	55	45	55	45 <sup>f</sup>	35
	S	UL	150	85	45	70	45	85 <sup>g</sup>	45 <sup>f</sup>	35

For SI: 1 foot = 304.8 mm.

UL = Unlimited; NS = Buildings not equipped throughout with an automatic sprinkler system; S = Buildings equipped throughout with an automatic sprinkler system installed in accordance with Section 903.3.1.1; S13R = Buildings equipped throughout with an automatic sprinkler system installed in accordance with Section 903.3.1.2; S13D = Buildings equipped throughout with an automatic sprinkler system installed in accordance with Section 903.3.1.3.

a. See Chapters 4 and 5 for specific exceptions to the allowable building height in this chapter.

## Step 2.1: Allowable Bldg. Height in Feet (continued)

**TABLE 504.3**  
**ALLOWABLE BUILDING HEIGHT IN FEET ABOVE GRADE PLANE<sup>a</sup>**

OCCUPANCY CLASSIFICATION	SEE FOOTNOTES	TYPE OF CONSTRUCTION								
		TYPE I		TYPE II		TYPE III		TYPE IV	TYPE V	
		A	B	A	B	A	B	HT	A	B
A, B, E, F, H-4 <sup>c</sup> M, S, U	NS <sup>b</sup>	80	80	65	30	55	30	65	30	15
	S	UL	150	85	45	70	45	85 <sup>g</sup>	45	30
H-1, H-2, H-3, H-5	NS <sup>c, d</sup>	(continued)		65	30	55	NP	65	NP	NP
	S									
I	NS <sup>b</sup>	80	80	65	30	55	30	65	30	NP
	S	UL	150	85						
R	NS <sup>b</sup>	80	80	65	30	55	30	65	30 <sup>e</sup>	20
	S13D	40	40	40	40	40	40	40	40	35
	S13R	55	55	55	45	55	45	55	45 <sup>f</sup>	35
	S	UL	150	85	45	70	45	85 <sup>g</sup>	45 <sup>f</sup>	35

For SI: 1 foot = 304.8 mm.

UL = Unlimited; NS = Buildings not equipped throughout with an automatic sprinkler system; S = Buildings equipped throughout with an automatic sprinkler system installed in accordance with Section 903.3.1.1; S13R = Buildings equipped throughout with an automatic sprinkler system installed in accordance with Section 903.3.1.2; S13D = Buildings equipped throughout with an automatic sprinkler system installed in accordance with Section 903.3.1.3.

a. See Chapters 4 and 5 for specific exceptions to the allowable building height in this chapter.

## Step 2.2: Allowable Stories Abv. Grade Plane

**TABLE 504.4  
ALLOWABLE NUMBER OF STORIES ABOVE GRADE PLANE<sup>a, b</sup>**

OCCUPANCY CLASSIFICATION	SEE FOOTNOTES	TYPE OF CONSTRUCTION								
		TYPE I		TYPE II		TYPE III		TYPE IV	TYPE V	
		A	B	A	B	A	B	HT	A	B
A-1	NS	UL	5	3	1	2	NP	2	1	NP
	S-13	UL	6	4	2	3	1	3	1	NP
A-2	NS	UL	10	3	1	2	NP	2	1	NP
	S-13	UL	11	4	2	3	1	3	1	NP
A-3	NS	UL	10	3	1	2	NP	2	1	NP
	S-13	UL	11	4	2	3	1	3	1	NP
A-4	NS	UL	10	3	1	2	NP	2	1	NP
	S-13	UL	11	4	2	3	1	3	1	NP
A-5	NS	UL	UL	UL	UL	*	*	*	*	*
	S-13	UL	UL	UL	UL	*	*	*	*	*
B	NS	UL	11	6	1	4	2	5	1	NP
	S-13	UL	12	7	2	5	3	6	2	1

## Step 2.2: Allowable Stories Abv. Grade Plane (continued)

**TABLE 504.4  
ALLOWABLE NUMBER OF STORIES ABOVE GRADE PLANE<sup>a, b</sup>**

OCCUPANCY CLASSIFICATION	SEE FOOTNOTES	TYPE OF CONSTRUCTION								
		TYPE I		TYPE II		TYPE III		TYPE IV	TYPE V	
		A	B	A	B	A	B	HT	A	B
A-1	NS	UL	5	3	1	2	NP	2	1	NP
	S-13	UL	6	4	2	3	1	3	1	NP
A-2	NS	UL	10	3	1	2	NP	2	1	NP
	S-13	UL	11	4	2	3	1	3	1	NP
A-3	NS	UL	10	3	1	2	NP	2	1	NP
	S-13	UL	11	4	2	3	1	3	1	NP
A-4	NS	UL	10	3	1	2	NP	2	1	NP
	S-13	UL	11	4	2	3	1	3	1	NP
A-5	NS	UL	UL	UL	UL	*	*	*	*	*
	S-13	UL	UL	UL	UL	*	*	*	*	*
B	NS	UL	11	6	1	4	2	5	1	NP
	S-13	UL	12	7	2	5	3	6	2	1

## Step 3: Verify Proposed Height is Allowed

Category	Actual Value	Maximum Allowed	OK?
Height (ft)	48.2 ft	85 ft	Yes
Height (stories above grade)	4 stories	7 stories	Yes

- Complete activity on p. I-99 to determine what other construction types would be allowable for this building.

KEY CONCEPT



### Three Approaches to Building Area

- Single occupancy
  - Accessory occupancies
  - Incidental uses
- Nonseparted mixed occupancy
- Separated mixed occupancy
  
- Possible to combine these approaches

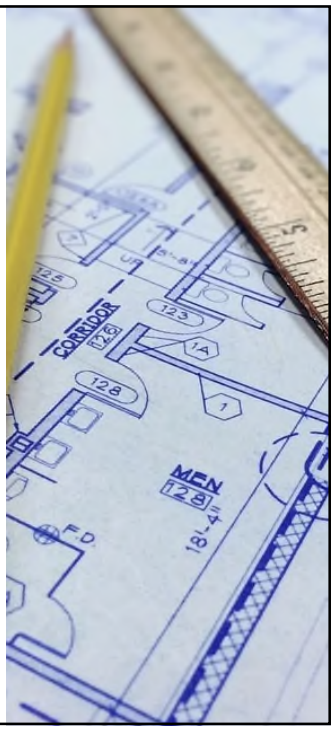

FOR EXAMPLE



## Single Occupancy (*Manual* p. I-102)

Single occupancy can include accessory occupancies:

- Grocery and pharmacy → main occupancy Group M
- Stockroom allowed as accessory storage (311.1.1)
- Café OL < 50, → Classify with main occupancy (303.1.2(1))
- Bank < 5% floor area → accessory occupancy (508.2)

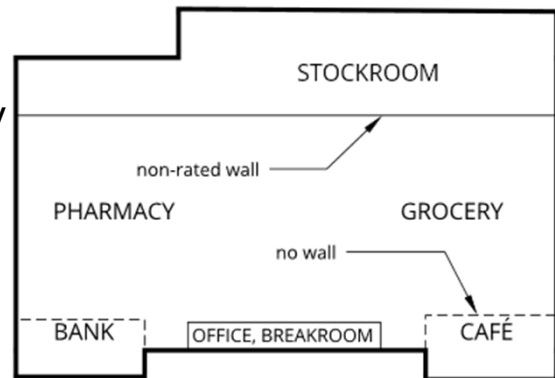

FOR EXAMPLE



## Nonseparated Mixed Occupancy

- Nonseparated mixed occupancies allowed (508.3)
- Classify each portion
- Use most restrictive height/area limits (*Group M areas more restrictive*)
- Use most restrictive Ch. 9 (fire protection) reqs. through fire area

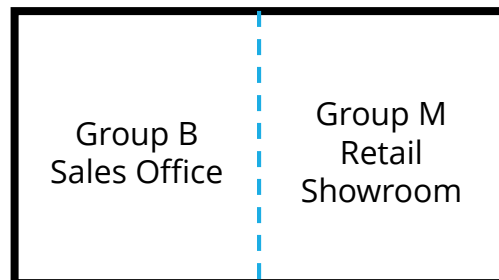

KEY CONCEPT



## 11 Steps to Check Area for Separated Mixed Occupancy

1. Verify occupancy classifications.
2. Verify construction type.
3. Verify height in feet and stories above grade plane.
4. Determine tabular allowed area factor ( $A_t$ ) and tabular nonsprinklered factor.
5. Calculate the increase factor for frontage ( $I_f$ ).
6. Check occupancy separations.
7. Calculate allowable area.
8. Check actual area  $\leq$  allowable area per occupancy.
9. Check actual area  $\leq$  allowable area for each story.
10. Check actual area  $\leq$  allowable building area.
11. Check actual height (feet and stories)  $\leq$  than allowable.

FOR EXAMPLE



## Mixed Occupancy Example (p. I-114)

- Basement
  - Parking Garage
- First Story Above Grade
  - Professional Office
  - Retail Store
  - Restaurant (OL  $\geq$  50)
- 2<sup>nd</sup> – 4<sup>th</sup> Stories
  - 8 apartments / story (24 total apartments)
- Mechanical/Rooftop Access Penthouse

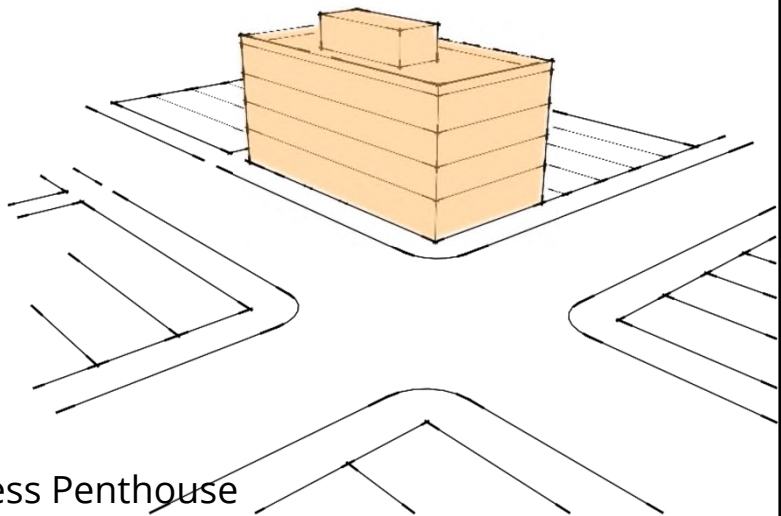

## Mixed Occupancy Example (continued)

### Step 1. Check Occupancy Classifications

- Groups **S-2** (parking garage), **A-2** (restaurant), **B** (office), **M** (retail store), **R-2** (apartments)

### Step 2. Check Construction Type

- Type VA (Protected Frame)

### Step 3. Check Bldg. Height in Feet and Stories Above Grade Plane

- 54 feet
- 4 stories above grade

### Step 4. Determine tabular allowed area factors ( $A_f$ ) and factors for nonsprinklered occupancies (NS)

## Mixed Occupancy Example (continued)

### Step 5. Calculate the area increase factor for frontage ( $I_f$ ) using Section 506.3.3.

- Use equation 5-5 (for detailed example see *Manual* p. I-106)
- Here, for rectangular corner building, because  $\frac{1}{2}$  perimeter faces public way  $> 30'$  and  $\frac{1}{2}$  perimeter faces open space  $< 20'$ ,  $I_f$  for sprinklered building is **100%**

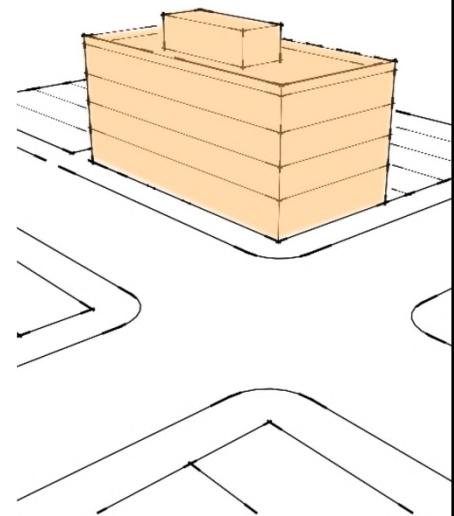

<b>SEPARATED MIXED-OCCUPANCY BUILDING: SPACE ALLOCATION</b>		
<b>Space</b>	<b>Occupancy Group</b>	<b>Floor Area</b>
<b>Basement</b>		
Parking Garage	Group S-2	7,000
TOTAL		7,000
<b>First Story Above Grade Plane</b>		
Professional Office	Group B	2,000
Retail Store	Group M	2,000
Restaurant	Group A-2	3,000
TOTAL		7,000
<b>Second Story Above Grade Plane</b>		
Apartments (8)	Group R-2	7,000
TOTAL		7,000
<b>Third Story Above Grade Plane</b>		
Apartments (8)	Group R-2	7,000
TOTAL		7,000
<b>Fourth Story Above Grade Plane (and Penthouse Above)</b>		
Apartments (8)	Group R-2	7,000
Mechanical Penthouse	Accessory to Group R-2	2,000
TOTAL		9,000

## Mixed Occupancy Example (continued)

Occupancy Groups: A-2, B, M, R-2, S-2  
 Construction Type: VA (protected frame)  
 Sprinkler System: Full NFPA 13  
 Proposed Height: 54 feet  
 4 stories above grade plane

Tabular factors:	$A_t$ (SM)	NS
A-2	9,000 ft <sup>2</sup>	3,000 ft <sup>2</sup>
B	18,000 ft <sup>2</sup>	6,000 ft <sup>2</sup>
M	15,000 ft <sup>2</sup>	5,000 ft <sup>2</sup>
R-2	15,000 ft <sup>2</sup>	5,000 ft <sup>2</sup>
S-2 (garage)	18,000 ft <sup>2</sup>	6,000 ft <sup>2</sup>

## Step 6: Check Occupancy Separations

- The basement parking garage must be separated from all other occupancies by construction with a fire-resistance rating of at least 3 hours per Section 406.2.8.
- The restaurant (A-2) must be separated from the business (B) and mercantile (M) occupancies by construction with a fire-resistance rating of at least 2 hours per Table 508.4.
- The restaurant (A-2) must be separated from the residential (R-2) occupancy by construction with a fire-resistance rating of 1 hour.
- The business (B) and mercantile (M) occupancies must be separated from the residential (R-2) occupancy by construction with a fire-resistance rating of 1 hour. (**Note:** the ordinance, as adopted, requires 3 hours, but this is believed to be an error).

## Step 7: Allowable Area per Occupancy

The allowable building area for each occupancy in a multi-story separated mixed-occupancy building is determined per Equation 5-3:

$$A_a = [A_t + (NS \times I_f)]$$

where:

- $A_a$  = Allowable area (square feet).
- $A_t$  = Tabular allowable area factor (NS, S13R, S13D or SM value, as applicable) in accordance with Table 506.2.
- $NS$  = Tabular allowable area factor in accordance with Table 506.2 for a nonsprinklered building (regardless of whether the building is sprinklered).
- $I_f$  = Area factor increase due to frontage (percent).



## Step 7: Allowable Area (continued)

The allowable building area for each occupancy in a multi-story separated mixed-occupancy building is determined per Equation 5-3:

$$A_a = [A_t + (NS \times I_f)]$$

Group A-2	$A_a = 9,000 \text{ ft}^2 + (3,000 \text{ ft}^2 \times 100\%) = 12,000 \text{ ft}^2$
Group B	$A_a = 18,000 \text{ ft}^2 + (6,000 \text{ ft}^2 \times 100\%) = 24,000 \text{ ft}^2$
Group M	$A_a = 15,000 \text{ ft}^2 + (5,000 \text{ ft}^2 \times 100\%) = 20,000 \text{ ft}^2$
Group R-2	$A_a = 15,000 \text{ ft}^2 + (5,000 \text{ ft}^2 \times 100\%) = 20,000 \text{ ft}^2$
Group S-2	$A_a = 18,000 \text{ ft}^2 + (6,000 \text{ ft}^2 \times 100\%) = 24,000 \text{ ft}^2$

## Step 8: Check Actual Area by Occupancy

Calculate the ratio of proposed floor area to allowable area for each occupancy on each story above grade plane. The ratio for each occupancy group on each story cannot exceed 1.

### First Story:

- Group A-2:  $3,000 \text{ ft}^2 \div 12,000 \text{ ft}^2 = 0.25$        $0.25 \leq 1$
- Group B:  $2,000 \text{ ft}^2 \div 24,000 \text{ ft}^2 = 0.083$        $0.083 \leq 1$
- Group M:  $2,000 \text{ ft}^2 \div 20,000 \text{ ft}^2 = 0.1$        $0.1 \leq 1$

### Second & Third Stories:

- Group R:  $7,000 \text{ ft}^2 \div 20,000 \text{ ft}^2 = 0.35$        $0.35 \leq 1$

### Fourth Story (incl. penthouse above):

- Group R:  $9,000 \text{ ft}^2 \div 20,000 \text{ ft}^2 = 0.45$        $0.45 \leq 1$

## Step 9: Check Actual Area by Story

Sum the ratios from Step 8 for each story above grade plane. The sum of the ratios for each story cannot exceed 1.

### First Story:

$$\bullet 0.25 + 0.083 + 0.1 = 0.433 \qquad 0.433 \leq 1$$

### Second & Third Stories:

$$\bullet 0.35 \qquad 0.35 \leq 1$$

### Fourth Story (incl. penthouse above):

$$\bullet 0.45 \qquad 0.45 \leq 1$$

## Step 10: Check Max. Building Area

Sum all ratios from Step 9 to determine if the building complies.

The sum of the ratios for all stories above grade plane cannot exceed 2 for a 2-story building or 3 for a building with 3 or more stories.

(Section 506.2.4)

$$0.433 + 0.35 + 0.35 + 0.45 = 1.583 \qquad 1.583 \leq 3$$

The total building area of 30,000 ft<sup>2</sup> is acceptable in Type VA construction with an automatic sprinkler system throughout.

## Step 11: Check Building Height/Stories

Occupancy	Actual Ht. (feet)	Max Height (feet)	Actual Ht. (stories)	Max Height (stories)	OK?
A-2	20 ft	45 ft	1	1	Yes
B	20 ft	45 ft	1	2	Yes
M	20 ft	45 ft	1	1	Yes
R-2	54 ft	55 ft*	4	4	Yes*
S-2	0 ft	45 ft	0	1	Yes

\* Per Table 504.3, note f, 55 feet provided the highest finished floor is no more than 40 feet above grade plane.



FOR EXAMPLE



## High-rise buildings

- High-rise buildings = buildings greater than 80' in building height (simpler than IBC definition)
- High-rise buildings have specialized requirements for construction, fire protection systems, means of egress, and elevators. ([Sec. 403](#))
- Task 2.7 (*Manual* p. I-123) provides an example of applying these specialized requirements.

REFERENCE



## For More Information . . .

- List of Special Occupancies and Uses in *Chicago Building Code* and *Interim Chicago Fire Prevention Code* (p. I-19)
- Task 2.7: Reviewing certain special occupancies and uses:
  - High-rise buildings
  - Motor-vehicle-related occupancies
  - Residential units (dwelling units, sleeping units, and shared cooking facilities)
  - Occupiable rooftops
  - Institutional occupancies

